

Strata

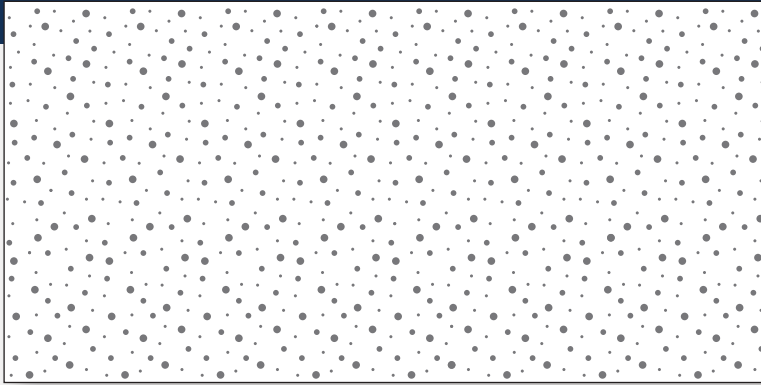



Strata panels are high density gypsum board with continuous sound absorbing perforations. They can be used on ceilings, walls and special applications where noise reduction is critical and architectural design is unique.

The random round perforations create a dramatic visual element that is easier to use on curves and bends where a straight line pattern may not look as nice.

STRATA 8/15/20

PERFORMANCE

-  **A 2-21, D0 (non-flammable)** according to DIN EN 13501
-  **Maximum Relative Humidity: 70%**
-  **Recycled Content: 86% (3% Post Consumer)**
- NRC: Up to .85**

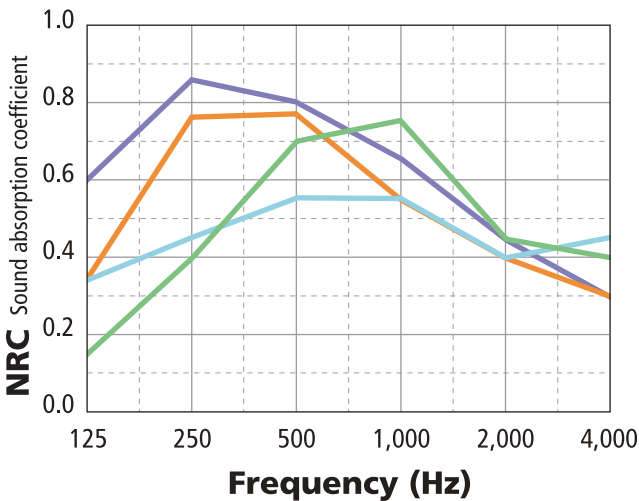

Cavity Depth 2" Felt Only	0.15	0.40	0.70	0.75	0.45	0.40
Cavity Depth 8" Felt Only	0.35	0.75	0.75	0.55	0.40	0.30
Cavity Depth 2" with 2" fiberglass	0.35	0.45	0.55	0.55	0.40	0.45
Cavity Depth 8" with 2" fiberglass	0.60	0.85	0.80	0.65	0.45	0.30

100% size to show pattern

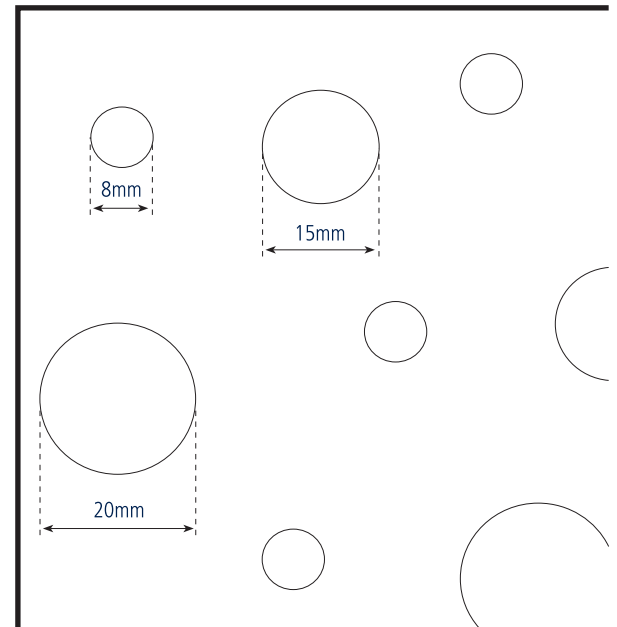

CHARACTERISTICS

Perforation Type:	8mm/15mm/20mm
Board Thickness:	1/2" (12.5mm)
Non-woven Fabric Backing:	Charcoal Gray
Finish:	Unfinished paper face
Open Area:	9.9%
Weight:	1.76 lbs / s.f.

AVAILABLE BOARD SIZES

- 1200mm x 2000mm (~47.24" x 78.74")
- 1200mm x 2500mm (~47.24" x 98.43")

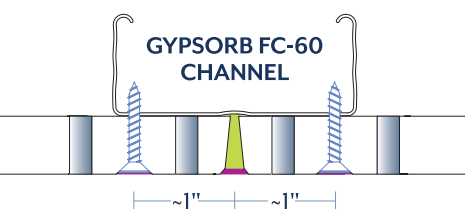

Joints are filled with **GypSorb Ready Mix** joint compound then skimmed over with **standard finishing compound**. Once dry, the joints are sanded smooth in order to receive prime and paint. See *Sonus/Strata Installation Principles* for further information.

